

REVISIONS					
REV	ECN	ECR-TN	DESCRIPTION	DATE	APR
A	16-00209	N/A	INITIAL RELEASE	08/19/16	RCL

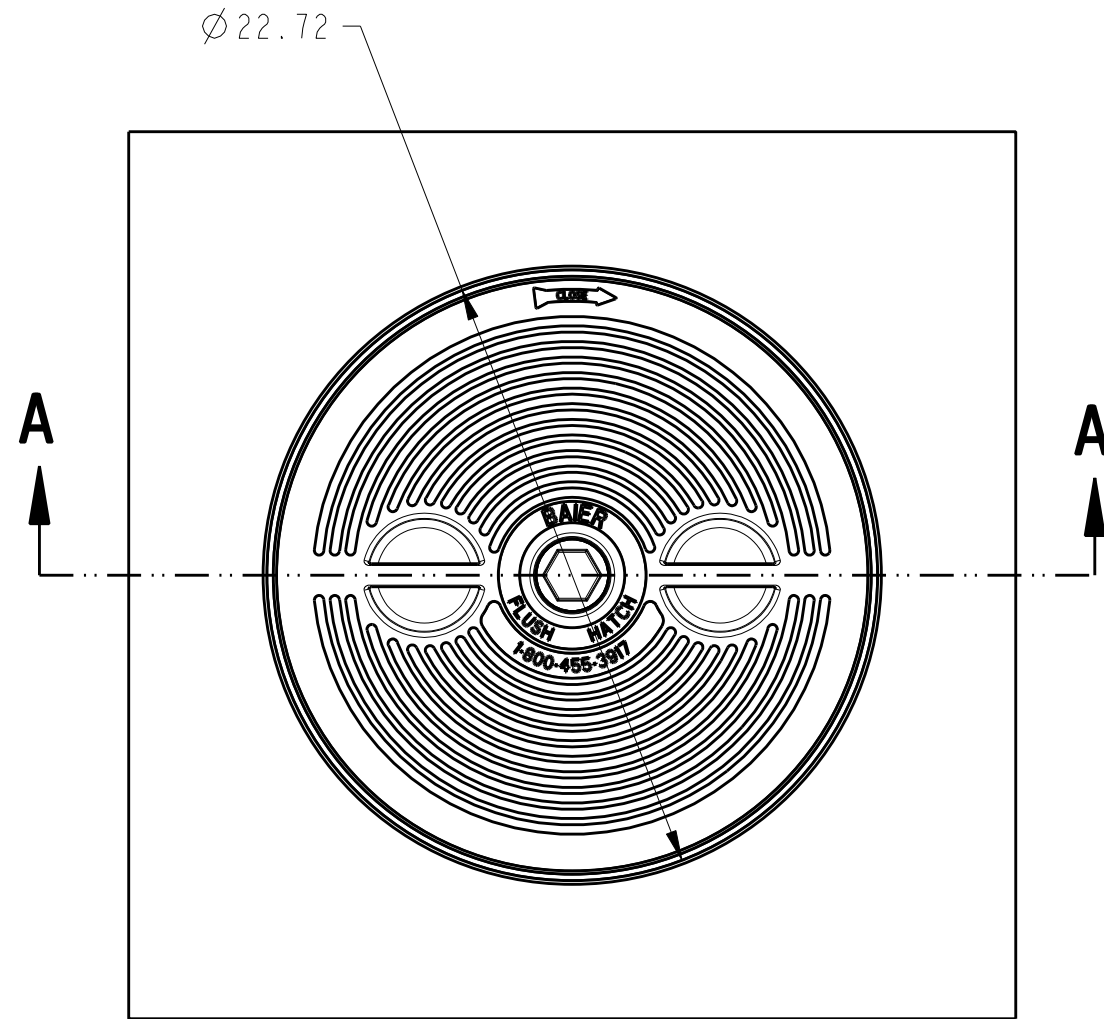

TOP VIEW
SCALE 7:50

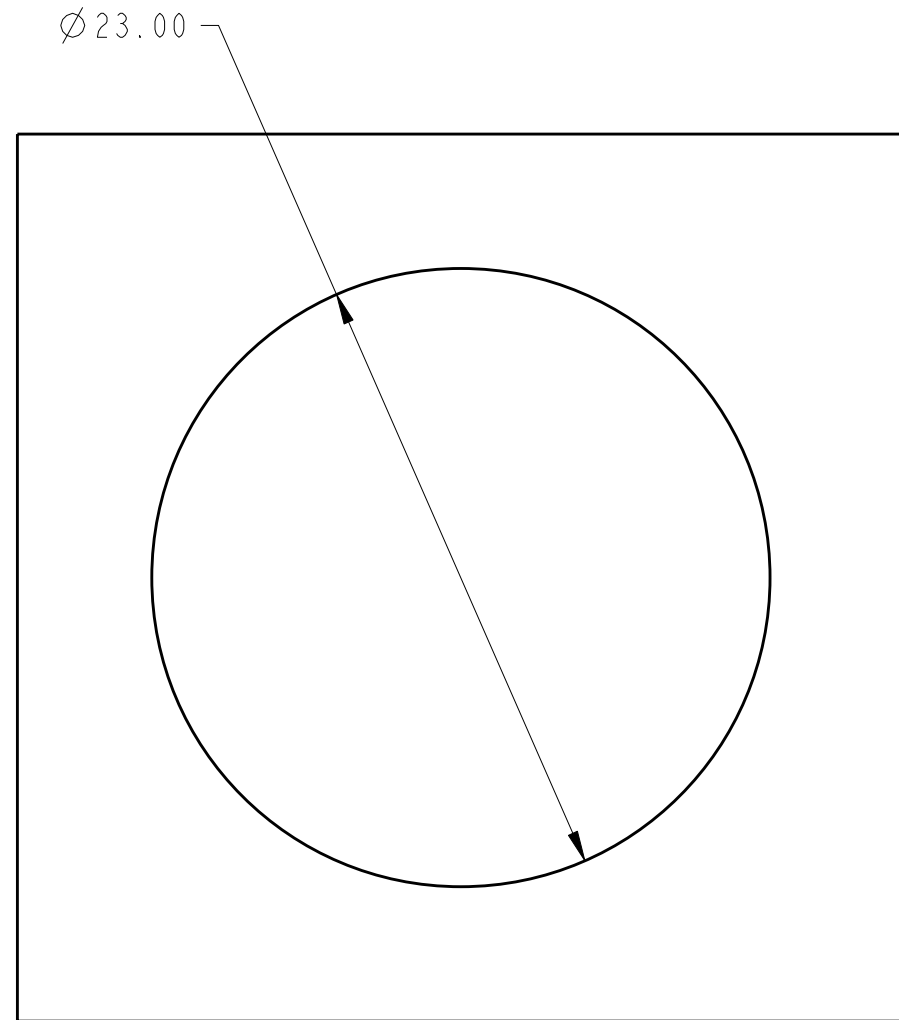

CUTOUT DIMENSION VIEW
SCALE 7:50

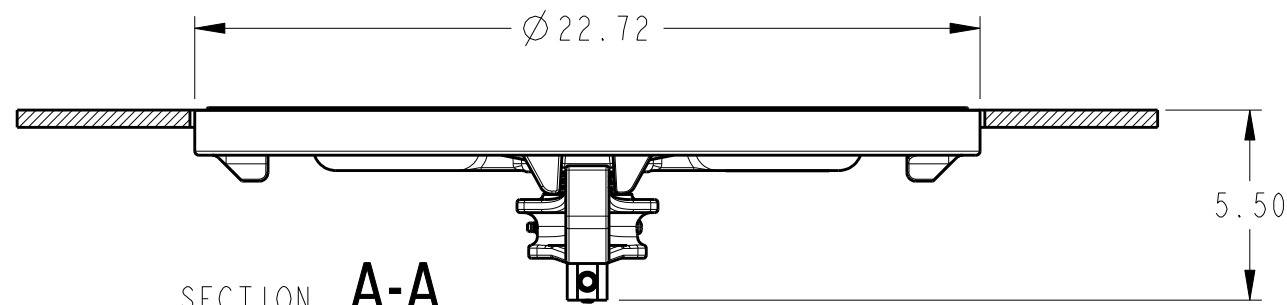

SECTION A-A
SCALE 9:50

PRO/E
THIRD ANGLE PROJECTION

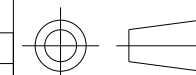

UMC P/N REF
08861-191B

THE INFORMATION CONTAIN IN THIS DOCUMENT IS PROPRIETARY AND SHALL NOT BE REPRODUCED OR USED FOR ANY PURPOSE WITHOUT THE WRITTEN APPROVAL OF BAIER MARINE CO., INC.

DWN	BAE	DT	01/07/16
CK		DT	
APR		DT	

BAIER
2920 Airway Ave., Costa Mesa, CA 92626

TITLE HATCH ASSY, AL-ST
20" ROUND

SIZE B	DWG NO. BFHR20A-S	REV A
SCALE 1:5 AND NOTED		SHEET 1 OF 1