

OPTIONAL: ESCAPE HANDWHEEL
(REPLACES ESCAPE HANDLE)

HATCH WEIGHTS LBS. (KGMS)*	
Model Number	BFHHQTH24X24
Material	AL ST
Cover	44 (20) N/A
Deck Ring	17.5 (8) 22.6 (10)
Hinge & Hardware	SS 8 (.36)

IMPORTANT: WHEN ORDERING, PLEASE SPECIFY
OUTSIDE DIAMETER (C) OR CLEAR OPENING (D).
UNITS ARE IDENTIFIED BY CLEAR OPENING.

Model Number	DIMENSIONS INCHES (mm)							
	A	B	C (ST)	C (AL)	D	E (ST)	E (AL)	F
BFHHQTH24X24	6 1/2 (165)	12 (305)	26 11/16 (677)	30 5/8 (778)	24 (610)	27.5 (699)	33 5/8 (854)	5/16 (8)

BILL OF MATERIAL: 08863-141

#	DESCRIPTION	MAT	P/N
1	COVER	AL	08864-241A
2	DOG HUB ASSY	AL	08864-102A
3	(4) DOG ARM	AL	08864-242A
4	GASKET	NEO	08864-706A
5	BUSHING	SS	08864-804A
6	O-RING	NEO	08864-702A
7	T-HANDLE	SS	08864-402A
8	DECK RING	AL	08863-246A
8	DECK RING	ST	08863-457A
9	ESCAPE HANDLE	AL	08864-213A
10	HANDLE PIN	SS	08864-801A
11	(4) NYLOCK NUT	SS	08864-807A
12	(4) WASHER	SS	08864-805A
13	(4) WASHER	UP	08864-803A
14	(4) THREADED POST	SS	08864-802A
15	GRAB HANDLE	SS	08863-405A
16	(4) ARM SPRING	SS	08864-809A
17	HINGE ASSY	DETAIL	08864-126A

MATERIAL KEY

AL - ALUMINUM
ST - GALV. STEEL
SS - STAINLESS STEEL
UP - UHMW POLY
NEO - NEOPRENE

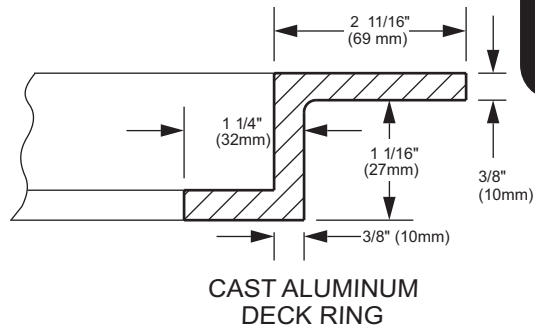
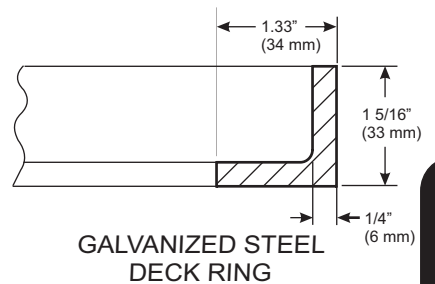
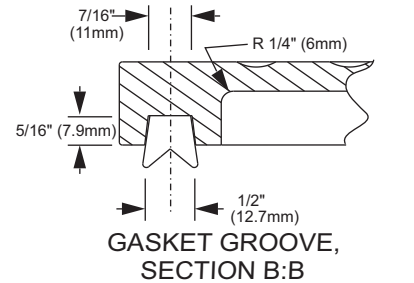

QUICK ACTING

BAIER Marine Company, Inc.
1-800-455-3917
206-632-2441 (FAX)
sales@baiermarine.com

BAIER FLUSH HATCH
INTERNAL HINGED MULTI-DOG
WITH BUILT-IN T-HANDLE
TYPE "D" QUICK ACTING
POSITIVE LOCK
MODEL BFHHQTH24X24

DWG. 08863-141

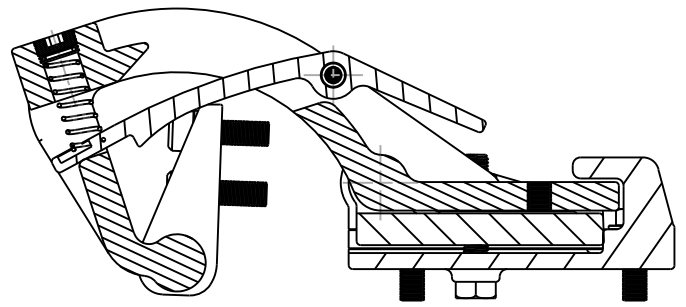
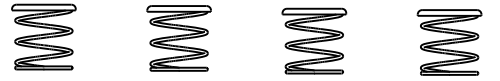
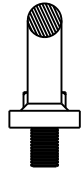
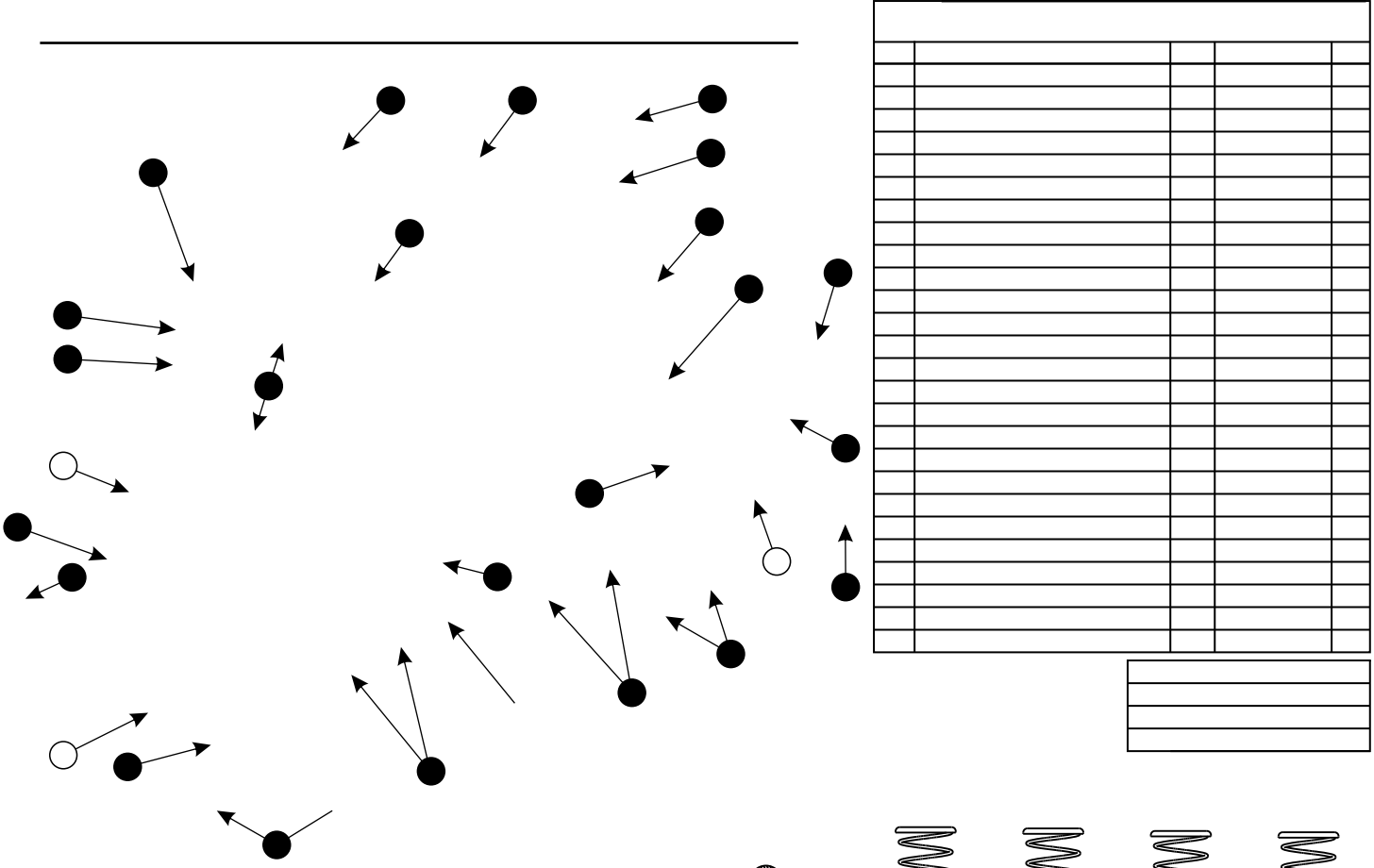

BAIER Marine Company, Inc.

