

BILL OF MATERIAL: 08863-115

#	DESCRIPTION	MAT	P/N
1	COVER	AL	08863-255A
2	DOG HUB ASSY	AL	08864-102A
3	(4) DOG ARM	AL	08864-203A
4	GASKET	NEO	08864-701A
5	BUSHING	SS	08864-804A
6	O-RING	NEO	08864-702A
7	T-HANDLE	SS	08864-401A
8	DECK RING	AL,ST	08863-257A,B
9	ESCAPE HANDLE	AL	08864-213A
10	HANDLE PIN	SS	08864-801A
11	(4) NYLOCK NUT	SS	08864-807A
12	(4) WASHER	SS	08864-805A
13	(4) WASHER	UP	08864-803A
14	(4) THREADED POST	SS	08864-802A
15	GRAB HANDLE	SS	08863-405A
16	(4) ARM SPRING	SS	08864-809A
17	HINGE ASSY	DETAIL	08864-126B

MATERIAL KEY

AL - ALUMINUM
ST - GALV. STEEL
SS - STAINLESS STEEL
UP - UHMW POLY
NEO - NEOPRENE

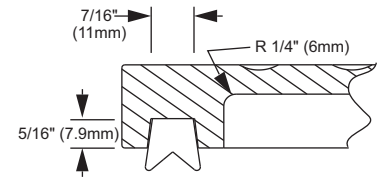

GASKET GROOVE, SECTION B:B

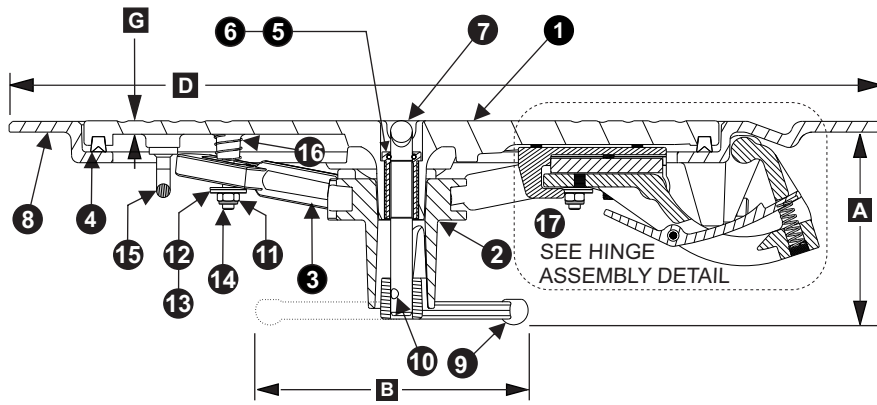

SECTION A:A

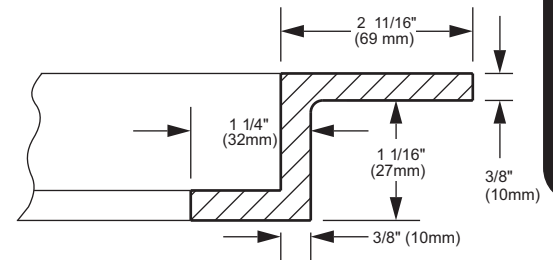

CAST ALUMINUM & GALVANIZED STEEL DECK RING

QUICK ACTING

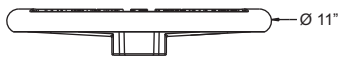

OPTIONAL: ESCAPE HANDWHEEL (REPLACES ESCAPE HANDLE)

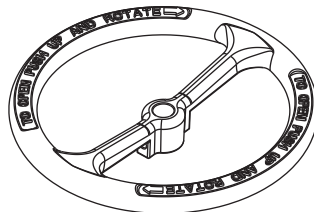

HATCH WEIGHTS LBS. (KGMS)*	
Model Number	BFHHQTH15X24
Material	AL ST
Cover	26.5 (12) N/A
Deck Ring	13.5 (6) 33 (15)
Hinge & Hardware	SS 8 (.36)

IMPORTANT: WHEN ORDERING, PLEASE SPECIFY OUTSIDE DIAMETER (C) OR CLEAR OPENING (D). UNITS ARE IDENTIFIED BY CLEAR OPENING.

Model Number	DIMENSIONS INCHES (mm)						
	A	B	C (AL&ST)	D (AL&ST)	E	F	G
BFHHQTH15X24	6 1/2 (165)	12 (305)	30.6 (777)	23 3/4 (603)	20 (508)	15 (381)	5/16 (8)

BAIER Marine Company, Inc.
 1-800-455-3917
 206-632-2441 (FAX)
 sales@baiermarine.com

BAIER FLUSH HATCH
 INTERNAL HINGED MULTI-DOG
 WITH BUILT-IN T-HANDLE
 TYPE "D" QUICK ACTING
 POSITIVE LOCK
MODEL BFHHQTH15X24

DWG. 08863-115

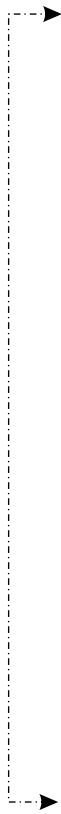
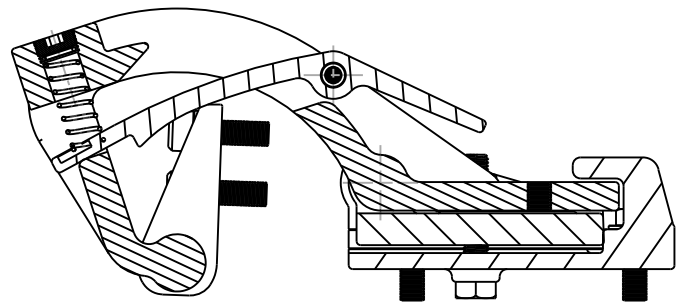
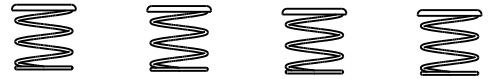
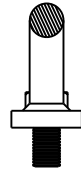
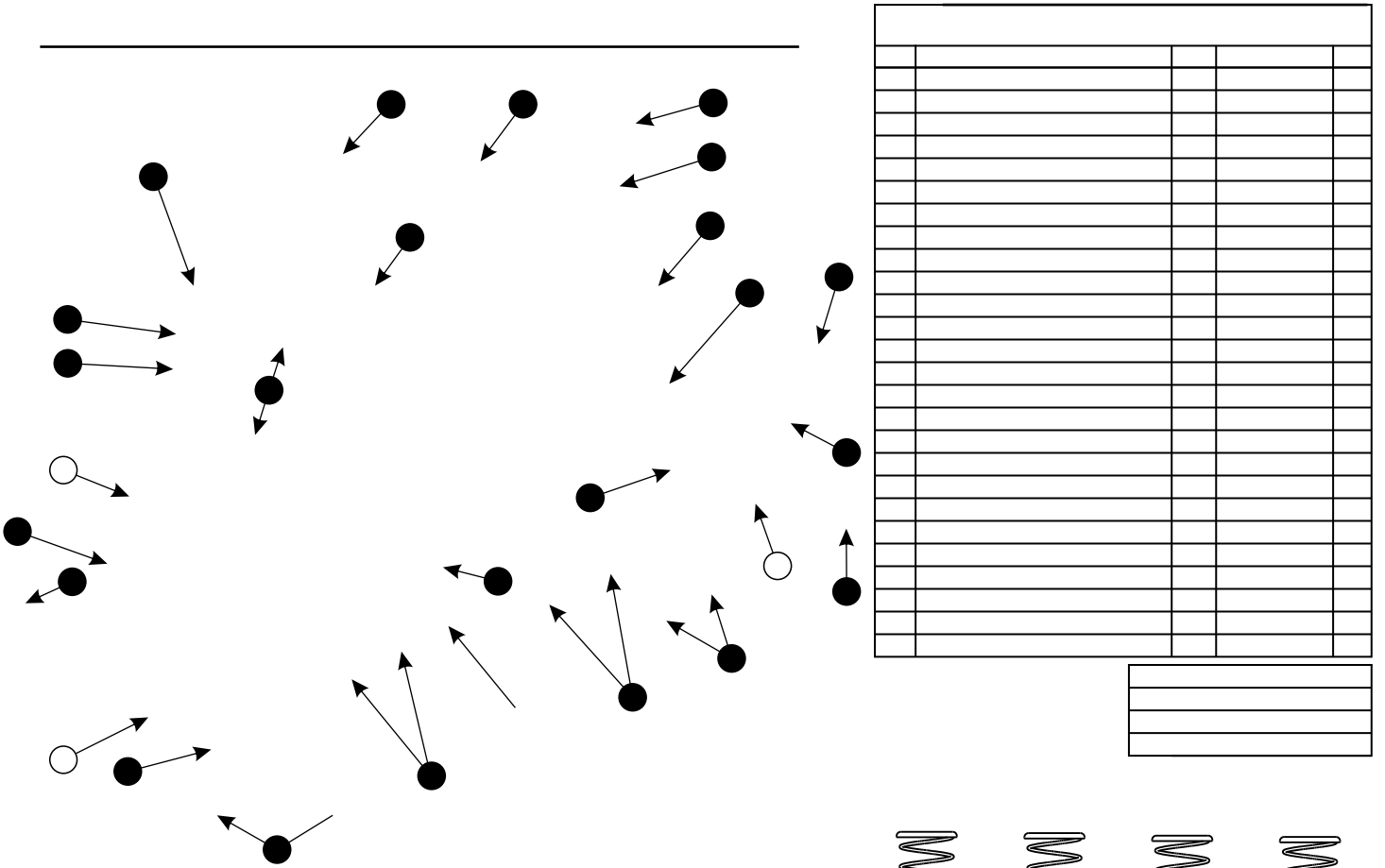

BAIER
Marine
Company, Inc.
